



universidad
de león

Más allá del LMS. Explorando los datos educativos en contextos web

Miguel Ángel Conde González



VNiVERSiDAD
D SALAMANCA

- Introducción
- Caso práctico CTMTC
- Caso práctico proyecto ILEDA
- Conclusiones

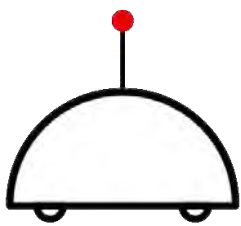

- **Introducción**
- Caso práctico CTMTC
- Caso práctico proyecto ILEDA
- Conclusiones

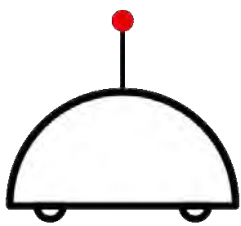

¿Qué usamos para aprender?



Entornos institucionales

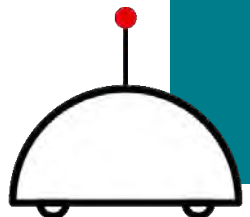

Live logs from the past hour

Displaying 25 records

Time	IP Address	Full name	Action	Information
Tue 5 September 2006, 01:33 AM	70.109.156.137	Teacher Demo	course report live	Moodle Features Demo
Tue 5 September 2006, 01:33 AM	128.173.54.50	Student Demo	resource view	How to install the Features
Tue 5 September 2006, 01:33 AM	128.173.54.50	Student Demo	course view	Moodle Features Demo
Tue 5 September 2006, 01:32 AM	128.173.54.50	Student Demo	hotpot view	3
Tue 5 September 2006, 01:32 AM	128.173.54.50	Student Demo	hotpot view	4
Tue 5 September 2006, 01:32 AM	128.173.54.50	Student Demo	hotpot view all	
Tue 5 September 2006, 01:32 AM	128.173.54.50	Student Demo	course view	Moodle Features Demo
Tue 5 September 2006, 01:30 AM	72.147.138.34	Admin User	calendar add	Test Results on Tuesady
Tue 5 September 2006, 01:30 AM	72.147.138.34	Admin User	forum view discussion	Linear Equations
Tue 5 September 2006, 01:29 AM	72.147.138.34	Admin User	course view	Moodle Features Demo
Tue 5 September 2006, 01:29 AM	72.147.138.34	Admin User	forum add discussion	Linear Equations
Tue 5 September 2006, 01:28 AM	72.147.138.34	Admin User	course view	Moodle Features Demo
Tue 5 September 2006, 01:25 AM	70.109.156.137	Teacher Demo	user view	Teacher Demo
Tue 5 September 2006, 01:25 AM	70.109.156.137	Teacher Demo	course report particip	4
Tue 5 September 2006, 01:18 AM	70.109.156.137	Teacher Demo	course report live	Moodle Features Demo

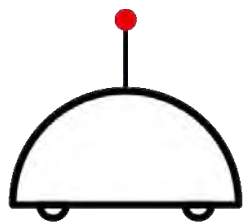



Learning Analytics

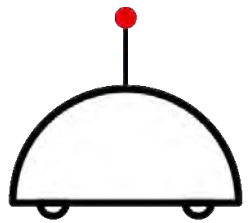

¿Solo usamos los LMS?

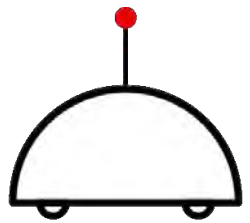

¿Entonces cómo hacemos?

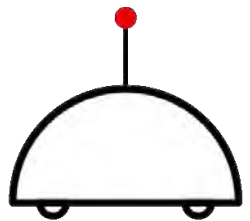

- **Introducción**
- Caso práctico CTMTC
- Caso práctico proyecto ILEDA
- Conclusiones

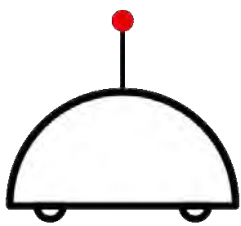

Trabajo en equipo



Metodología – Caja blanca

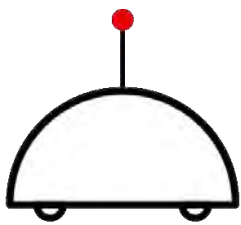

Metodología – Caja blanca



- FORMACIÓN EQUIPO
FORMING
- AGITACIÓN
STORMING
- NORMALIZACIÓN
NORMING
- EJECUCIÓN
PERFORMING
- ENTREGA
- DOCUMENTACIÓN

FASES
FORMACIÓN DEL EQUIPO
MISIÓN Y OBJETIVOS
NORMATIVA
MAPA RESPONSABILIDADES
SEGUIMIENTO Y COORDINACIÓN
PLANIFICACIÓN
EJECUCIÓN
DOCUMENTACIÓN
RESULTADOS

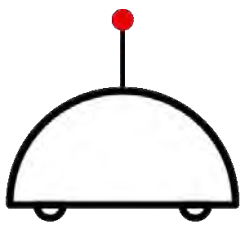

Metodología – Caja blanca

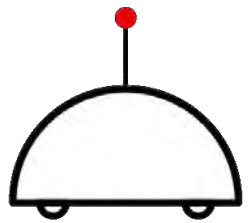

Deployment Diagram

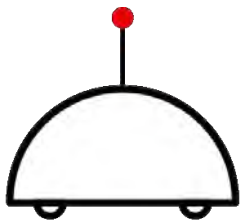
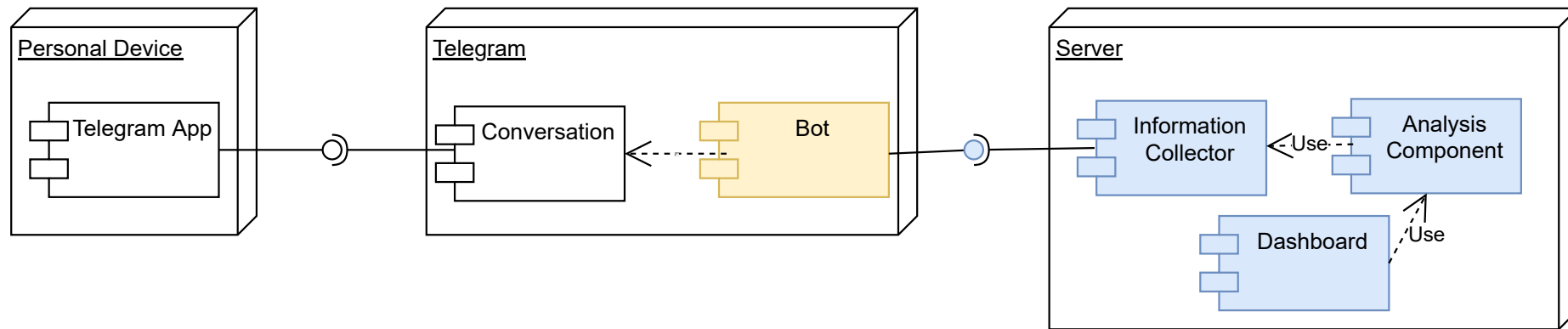

The dashboard in general

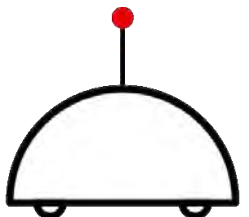
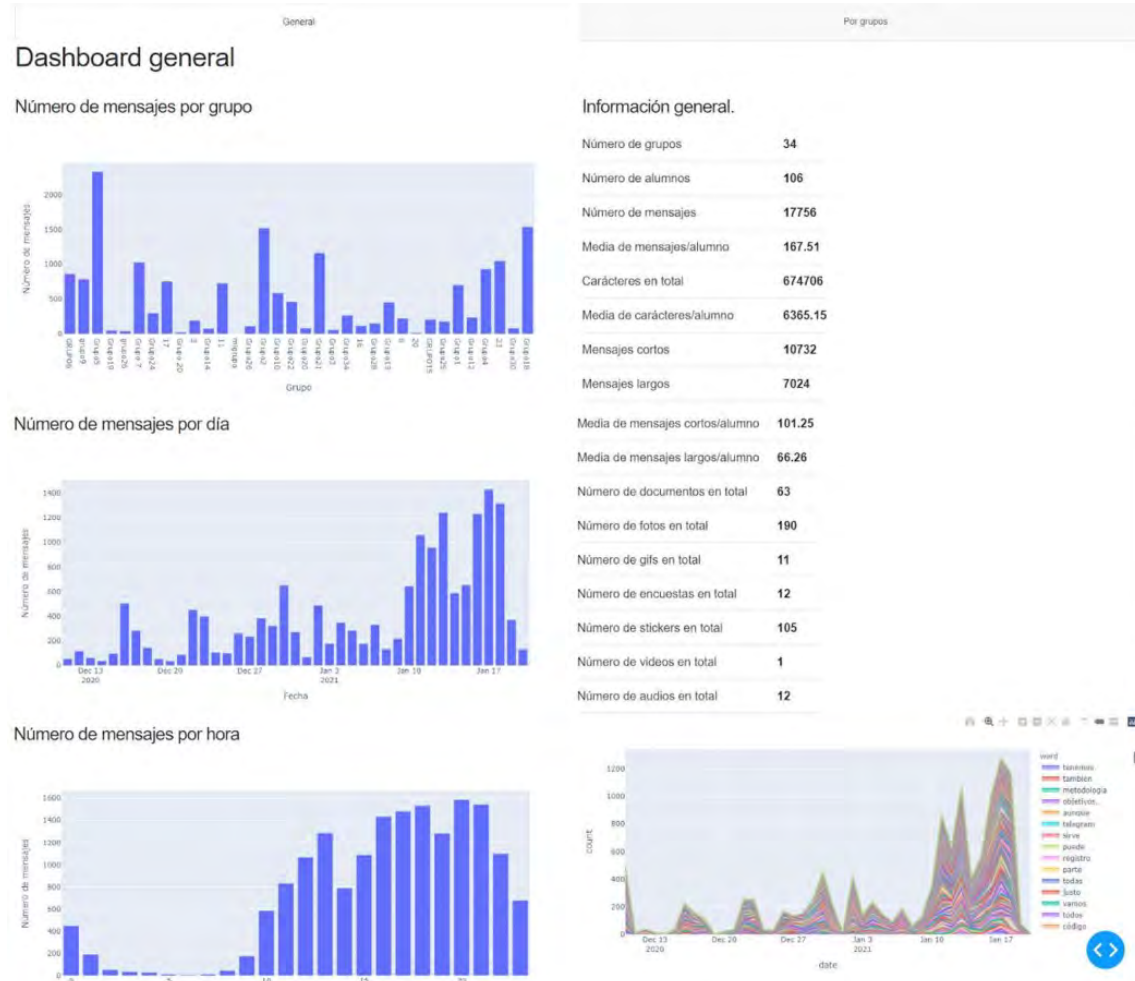

The dashboard for a group

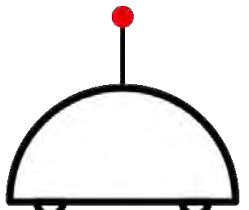
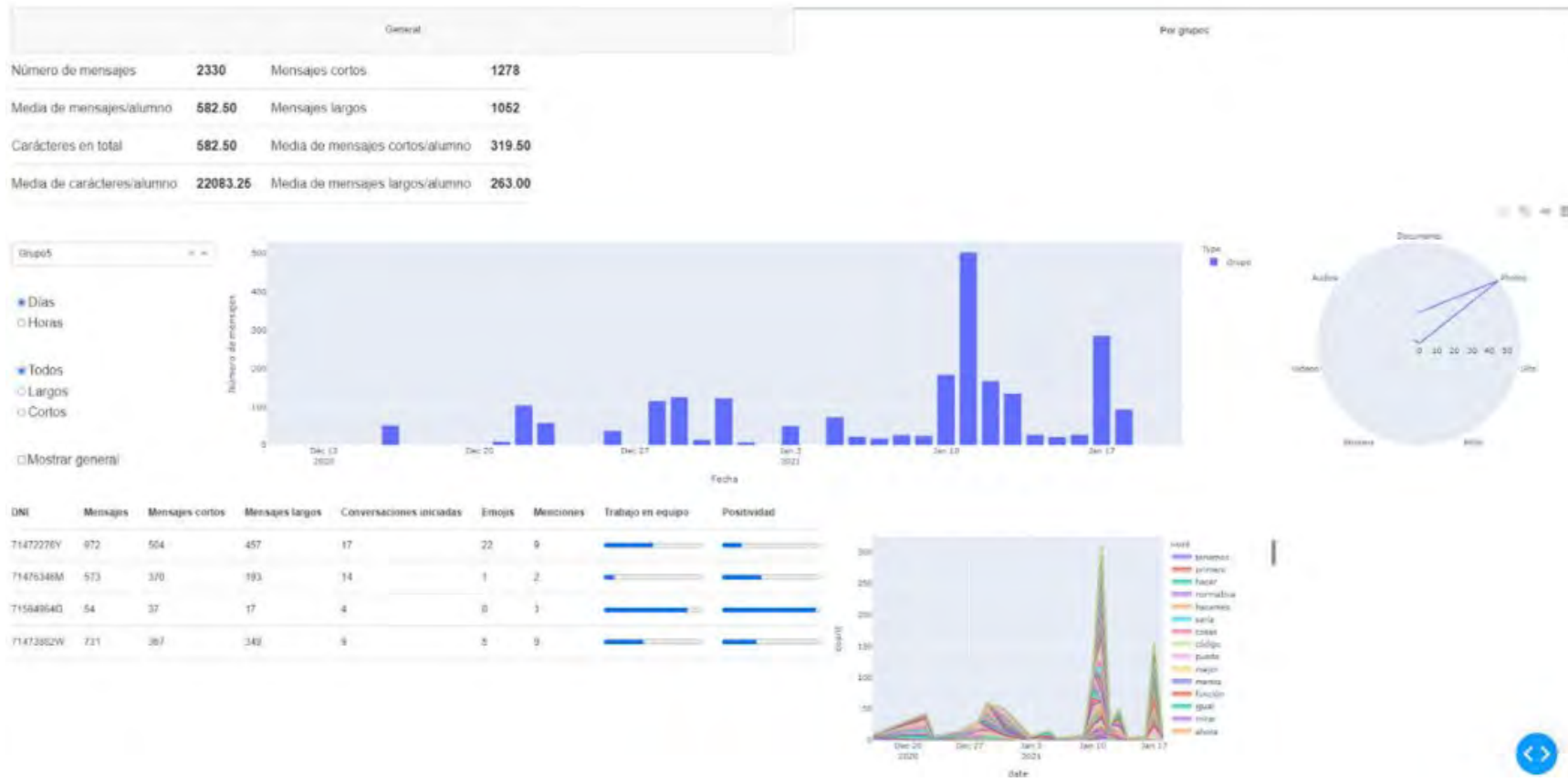

- Introducción
- Caso práctico CTMTC
- **Caso práctico proyecto ILEDA**
- Conclusiones

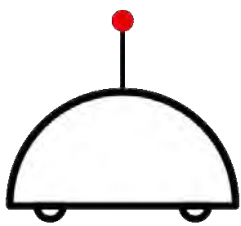

Herramientas



Adobe Stock | #354669190

Heterogeneity



Solución común



Análisis

- Sistemas empleados
- Herramientas de LA disponibles
- Políticas de LA
- Políticas de acceso a datos
- Contexto de aplicación
- Ética
- Ayuda de expertos

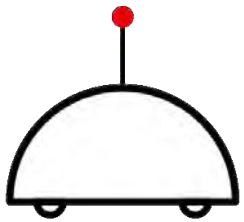

Pilotaje

- 2 cursos por institución (PBL y Flipped Classroom)

- 800 students

- Métricas

- Notas

- Uso de recursos (videos, documentos, actividades, material de lectura, etc.)

- Otros (inicios de sesión, tiempo de sesión, etc)

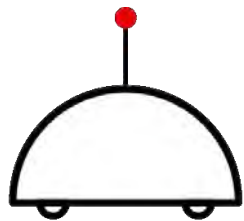
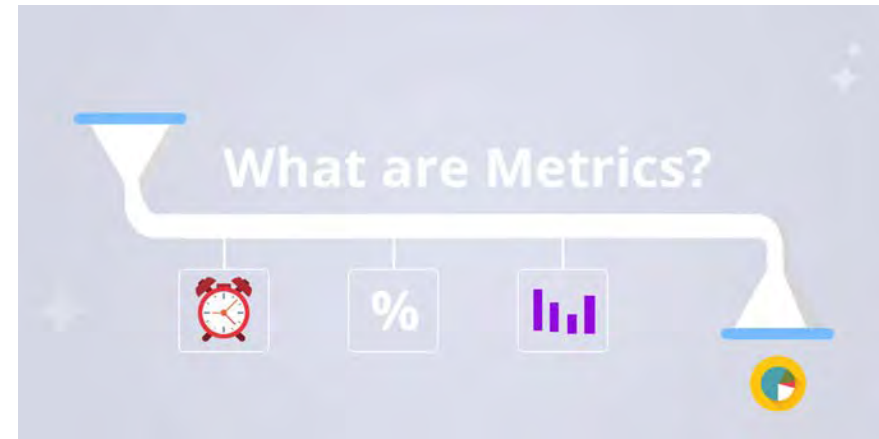

Procedimiento para usar el sistema

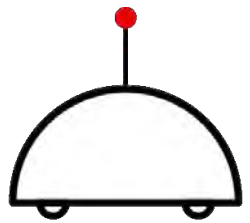
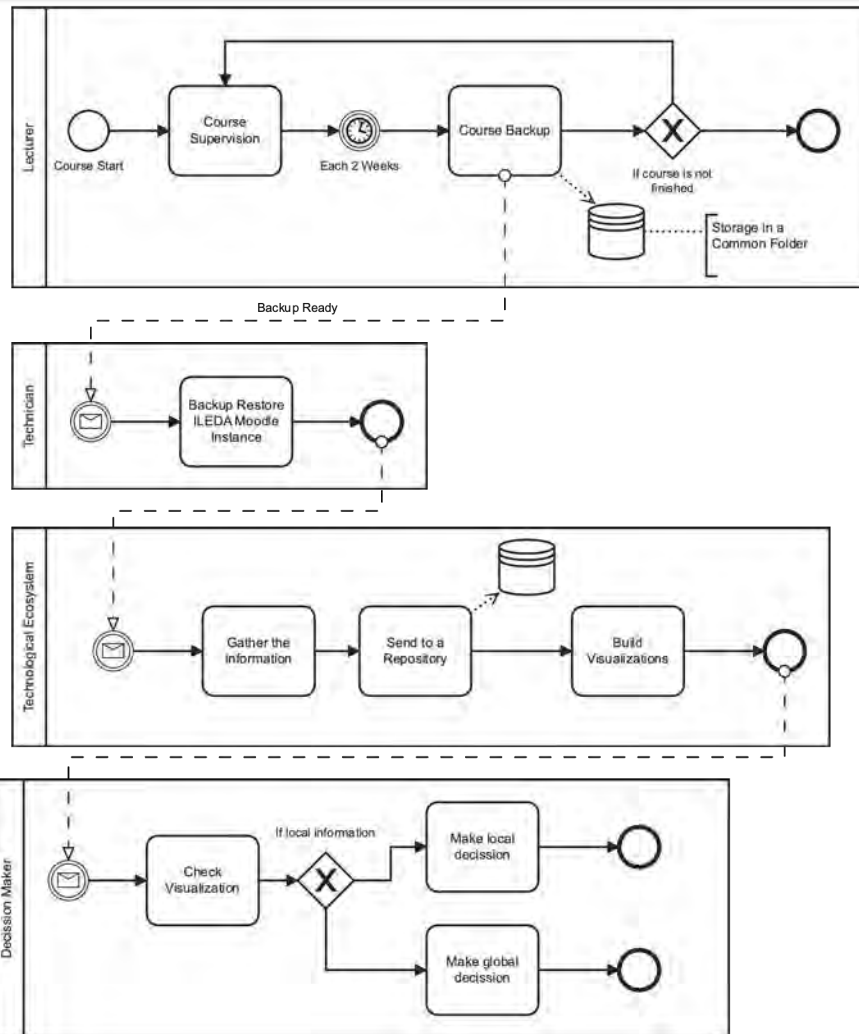

Solución Estándar



shutterstock.c

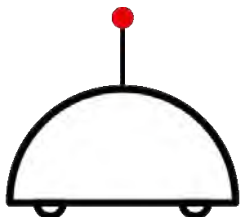
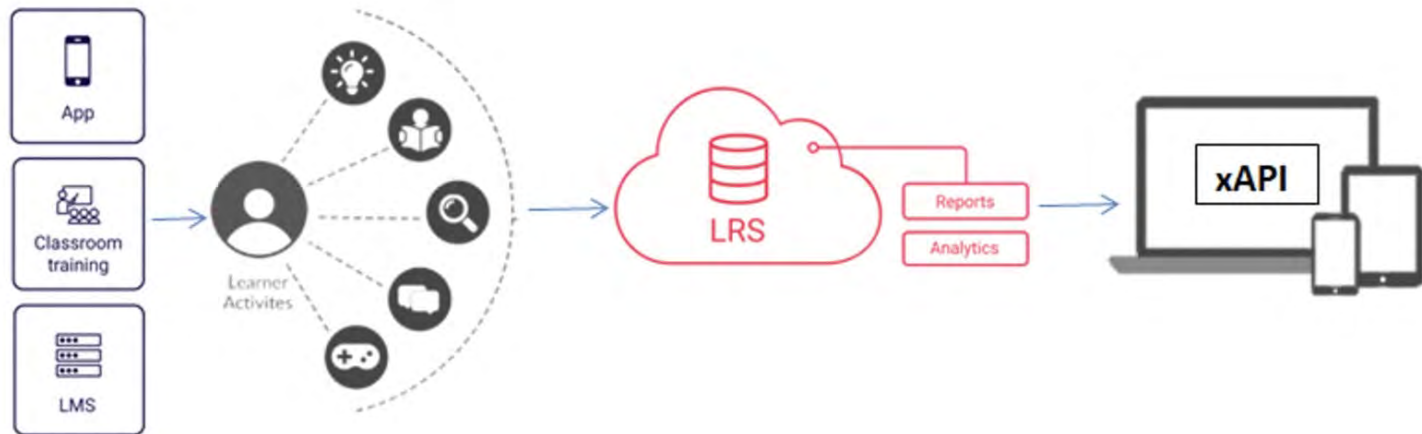

xAPI en el proyecto



Diagrama de actividad



El dashboard del LRS

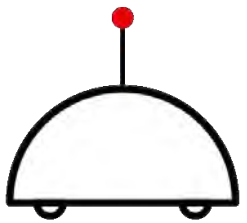
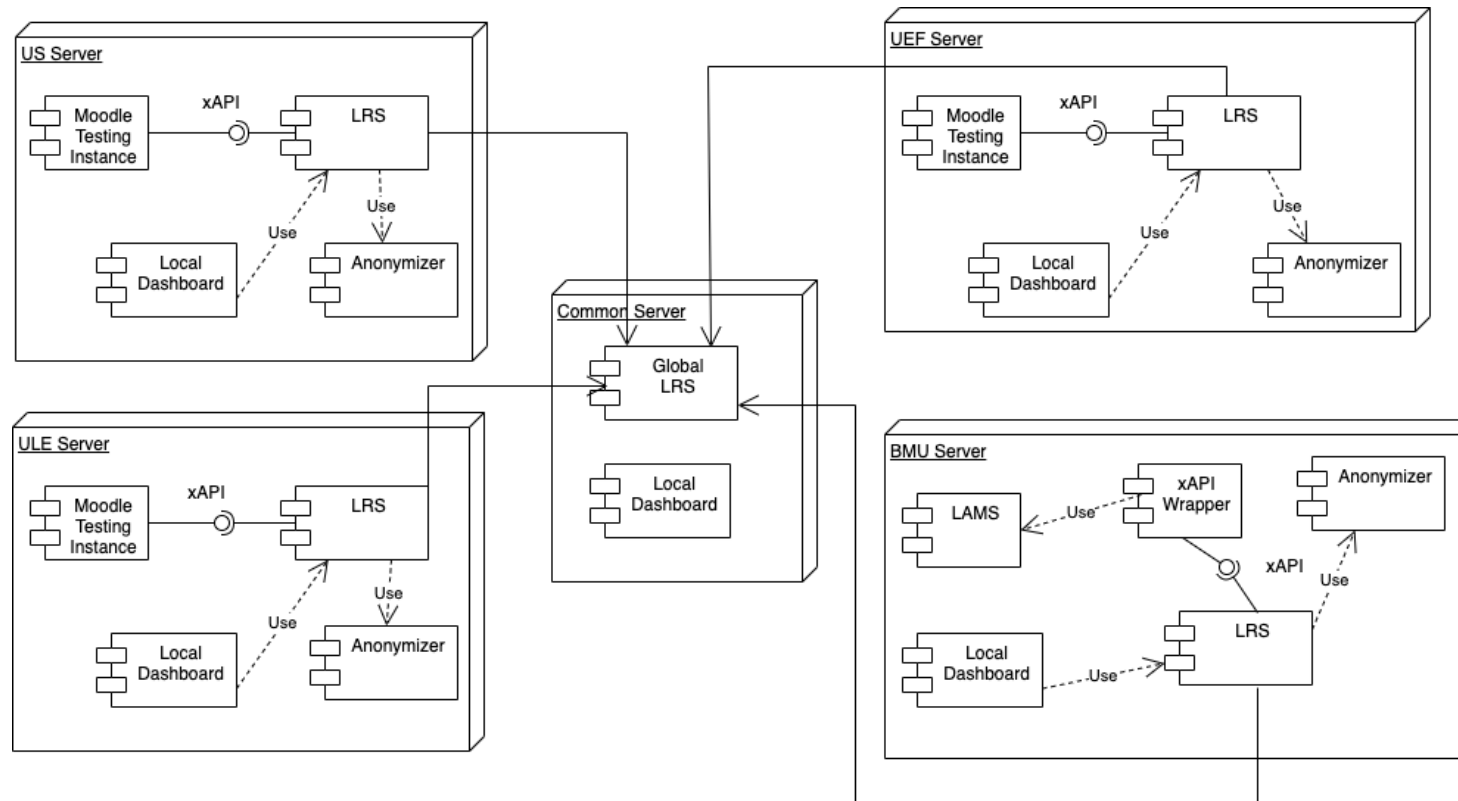
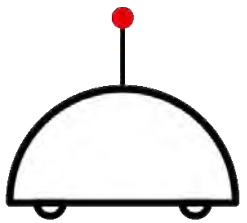
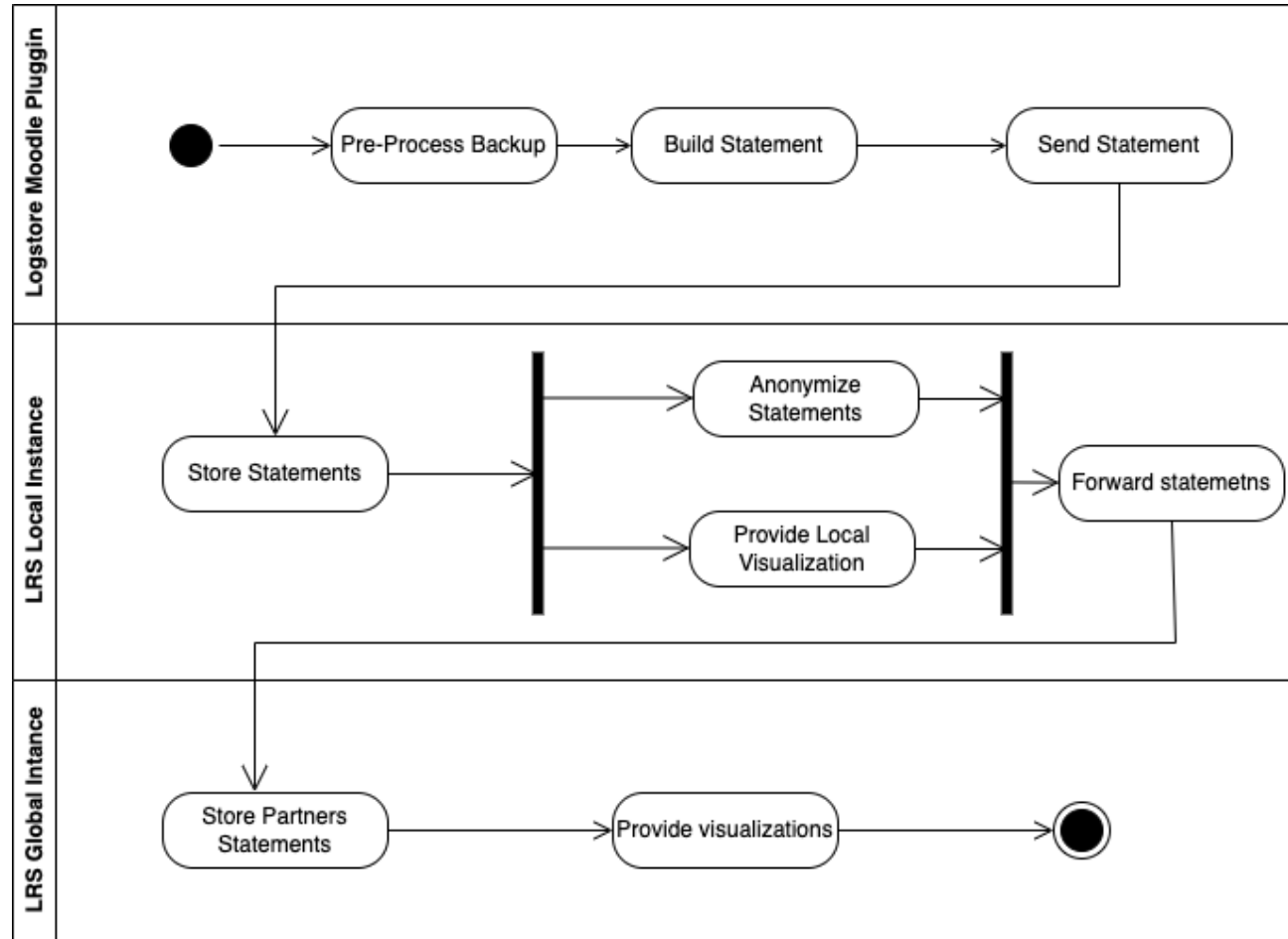
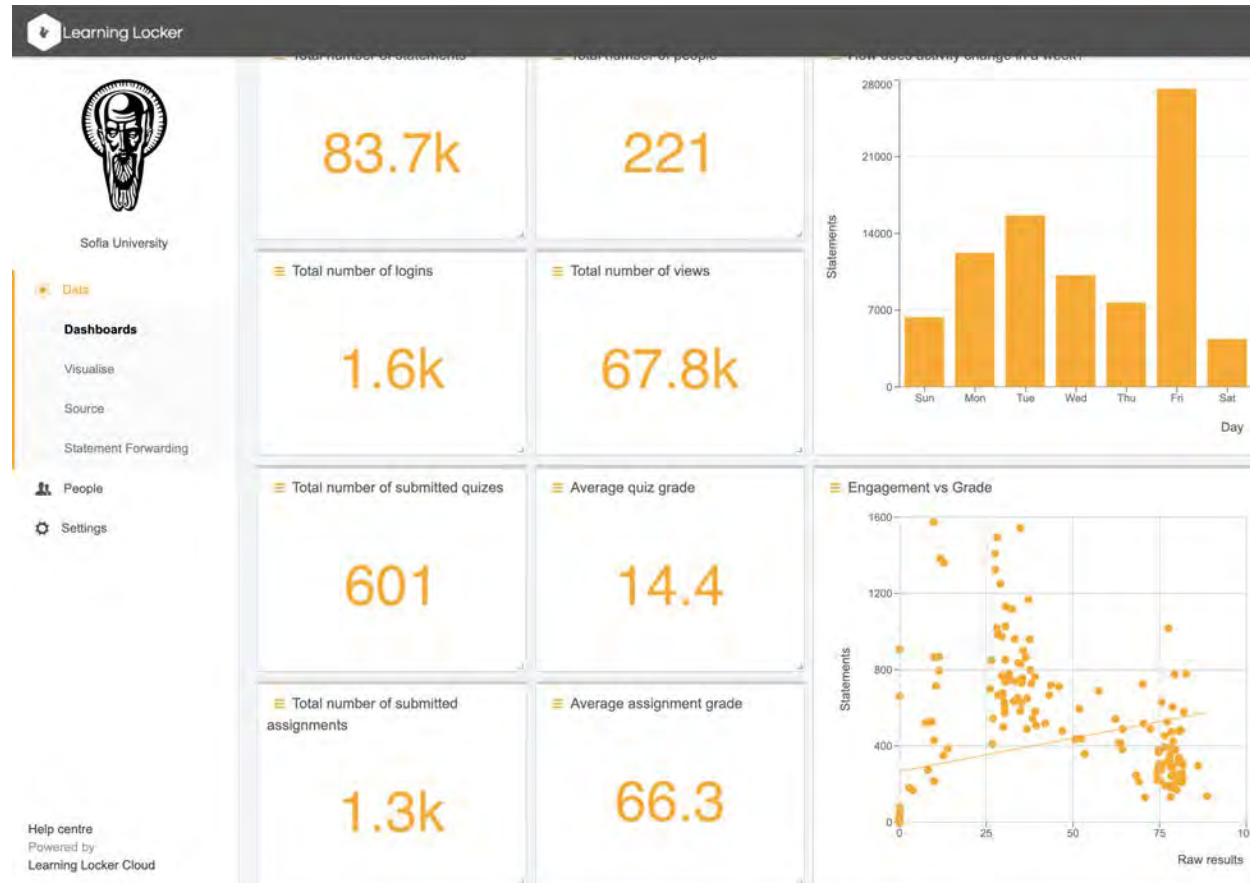

- Introducción
- Caso práctico CTMTC
- Caso práctico proyecto ILEDA
- **Conclusiones**

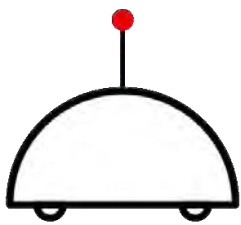

Flexibilidad





universidad
de león

Más allá del LMS. Explorando los datos educativos en contextos web

Miguel Ángel Conde González



VNiVERSiDAD
D SALAMANCA